



**Whitehaven®**  
23-1/2" undermount single-bowl farmhouse kitchen  
sink  
**K-5664**

### Features

- Fits minimum 24" (610 mm) base cabinet width
- Single bowl
- 9" (229 mm) depth provides generous workspace
- Shortened apron allows sink to be used in most standard cabinetry or retrofitted to existing standard cabinetry
- Self-Trimming® apron overlaps cabinet face for easy installation and beautiful results

### Material

- KOHLER® enameled cast iron

### Installation

- Center drain
- Cutout templates included
- Undermount

### Recommended Products/Accessories

- K-8395 Sink Rack
- K-8801 Sink drain and strainer with tailpiece
- K-8799 Sink drain and strainer basket
- K-23726 Drain treatment
- K-23725 Cast iron cleaner

### Optional Products/Accessories

- K-11352 Disposal Flange with Stopper
- K-9000 P-Trap



### Codes/Standards









ASME A112.19.1/CSA B45.2

### KOHLER® Enameled Cast Iron Kitchen and Bathroom Sink Lifetime Limited Warranty

See website for detailed warranty information.

### Available Colors/Finishes

*Color tiles intended for reference only.*

Color	Code	Description
	0	White
	FF	Sea Salt™
	96	Biscuit
	NY	Dune
	95	Ice™ Grey
	58	Thunder™ Grey
	7	Black Black™
	TRF	Truffle

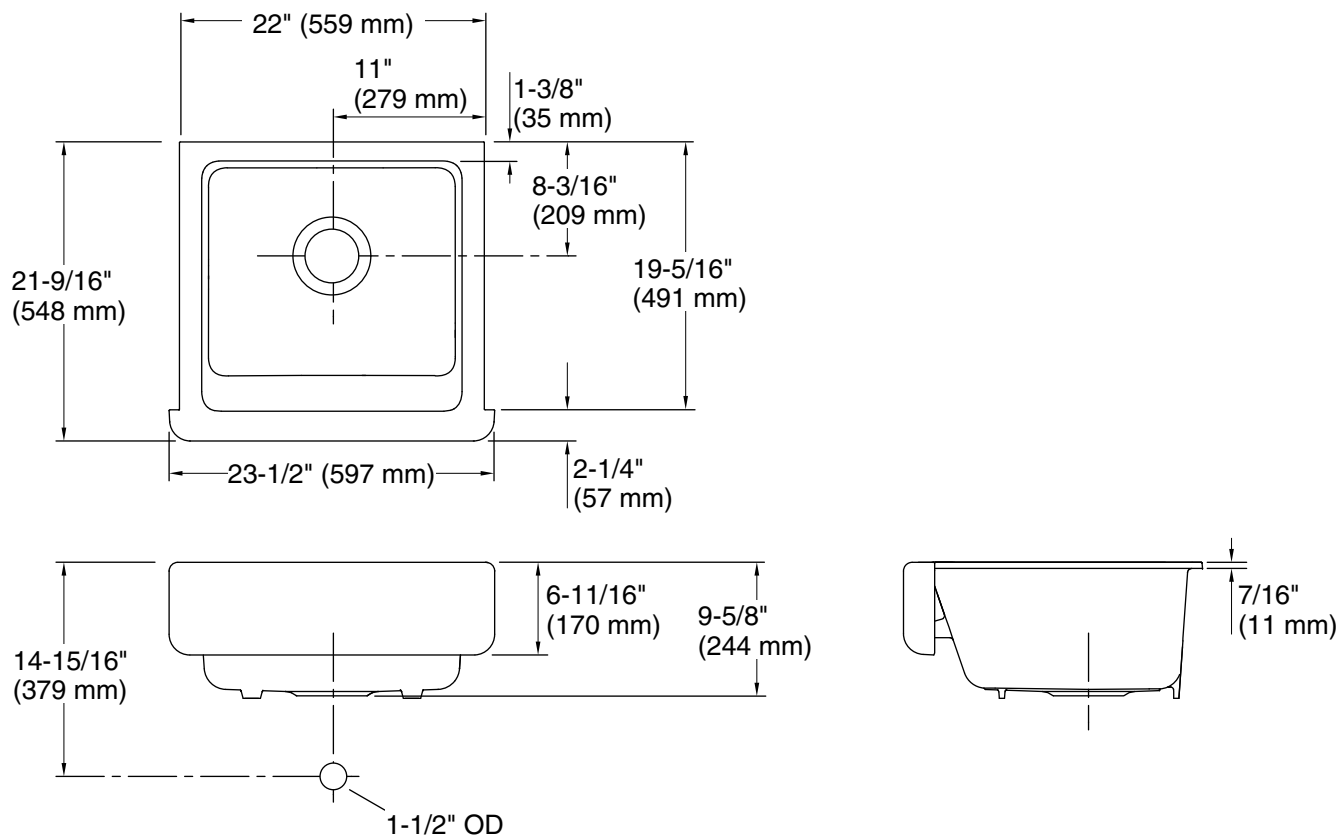

## Technical Information

All product dimensions are nominal.

Bowl configuration:	Single
Min. base cabinet width:	24" (610 mm)
Bowl area (Only):	Length: 18-13/16" (477 mm) Width: 18-1/16" (459 mm) Bowl depth: 9" (229 mm) Water depth: 9" (229 mm)
Drain hole:	3-5/8" (92 mm)
Template:	1247776-7, required, included 1239229-7, required, included

## Notes

Install this product according to the installation instructions.

**NOTICE:** Countertop manufacturer or cutter must use the current product template available at [www.kohler.com](http://www.kohler.com), or by calling 1-800-4KOHLER. Kohler Co. is not responsible for cutout errors when the incorrect cutout template is used.

**IMPORTANT!** The distance from the top edge of the cabinet to the top of the cabinet door must be at least 6-7/8" (175 mm) to install this sink.